



URE-Sicherungen

Sicherungseinsätze britischer Norm

URE Fuses

Fuse-links british standard

Technische Daten nach Baureihen /
Technical Data Types of Fuses

Technische Daten Sicherungs-Unterteile /
Technical Data Fuse Bases

150 V

2 x 35 x 59 mm

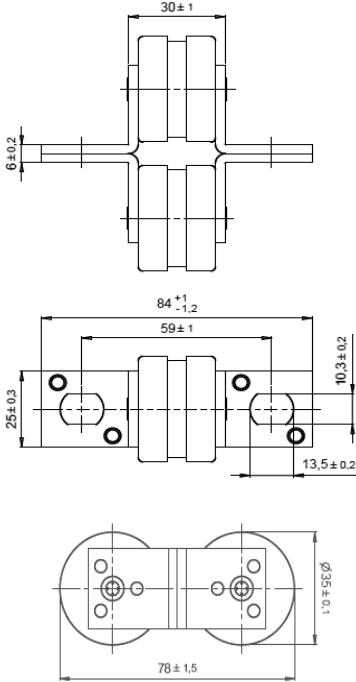
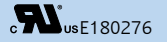

Verpackungseinheit / Packing unit: 1 Stück / 1 pieces

Betriebsklasse / Class aR	UL 248-13		
Bemessungsspannung Rated Voltage	Artikel Nr. Article No	Größe Size	Bemessungsstrom Rated Current
V		mm	A
150	50 071 38	2 x 35 x 59	300-900

Bemessungsausschaltvermögen / Rated breaking capacity 40 kA DC 150 V L/R = 7 ms

Bemessungsstrom Rated Current	Artikel Nr. Article No.	Gewicht Weight	Schmelz- integral Pre-Arcing- I ² t-Value	Ausschalt- integral Total I ² t-Value	Leistungs- abgabe Power Loss
A		kg / 1	A ² s	A ² s @ AC 240 V	W
300	50 071 38.300	0,29	5.300	20.000	46
350	50 071 38.350	0,29	8.200	30.500	48
400	50 071 38.400	0,29	10.000	37.000	68
450	50 071 38.450	0,29	18.500	68.000	50
500	50 071 38.500	0,29	34.000	125.000	45
630	50 071 38.630	0,29	50.000	140.000	73
710	50 071 38.710	0,29	70.000	195.000	77
800	50 071 38.800	0,29	106.000	294.000	81
900	50 071 38.900	0,29	145.000	402.000	98

150 V

2 x 35 x 59 mm

 cULusE180276

Zeit/Strom-
Kennlinien
Time-current
characteristics

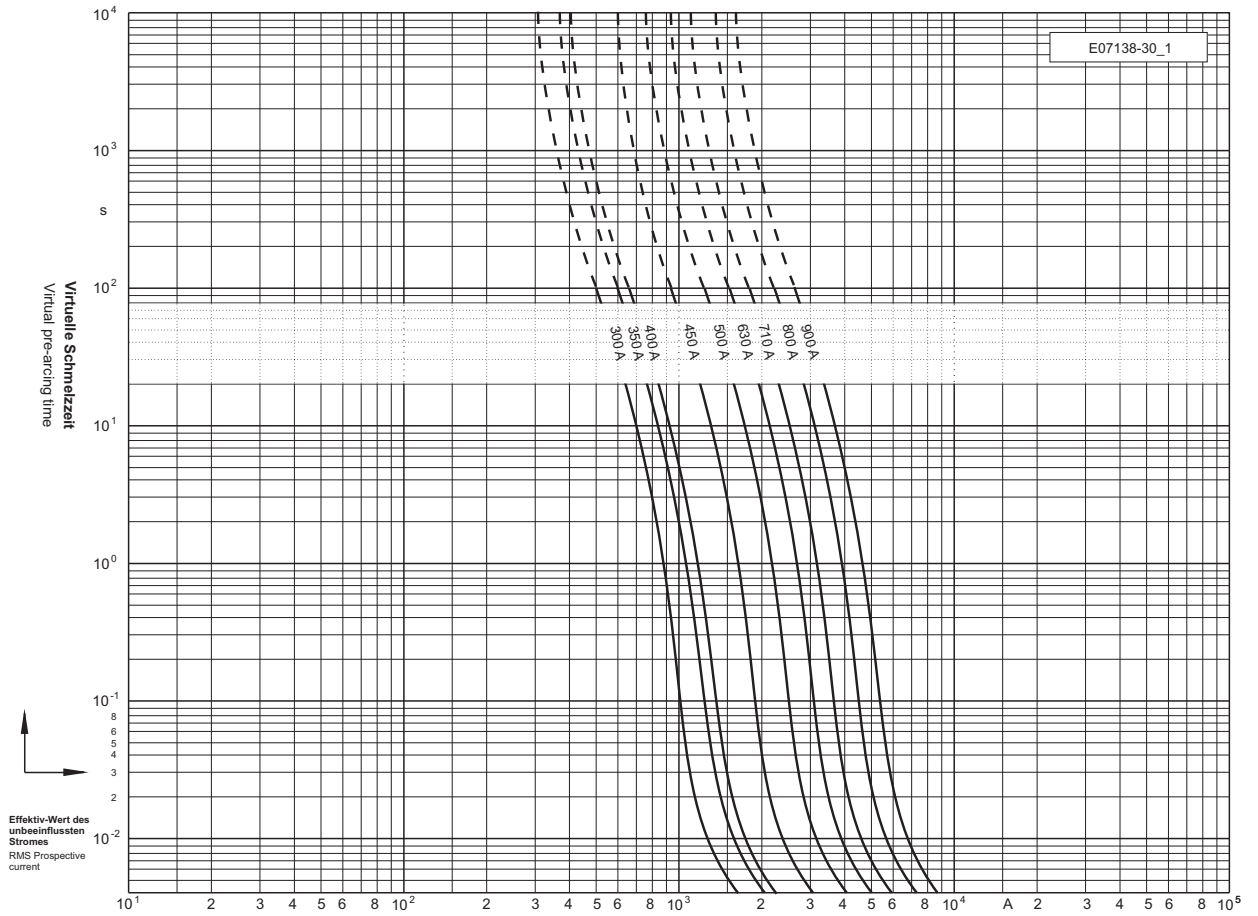

240 V

Ø 8,4 x 38 mm

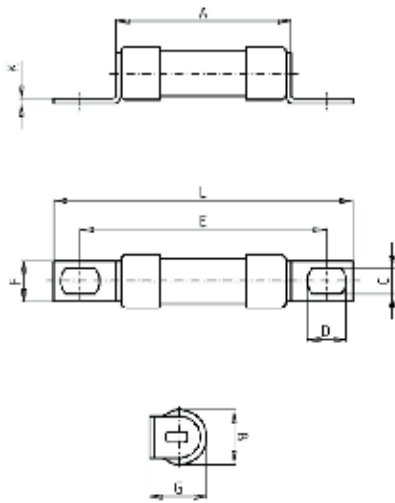

Verpackungseinheit / Packing unit: 50 Stück / 50 pieces

Betriebsklasse / Class aR	IEC 60 269-4 VDE 0636-4 BS 88-4
-------------------------------------	--

Bemessungs- spannung Rated Voltage	Artikel Nr. Article No	Größe Size	Typ Type	Bemessungsstrom Rated Current
V		mm		A
240	50 076 06	8,4 x 38	SLCT	5-20

Artikel Nr. Article No.	Länge Length									
	A	B	C	D	E	F	G	K	L	
	mm	mm	mm	mm	mm	mm	mm	mm	mm	
50 076 06	27	8,4	4	6	38	6,4	9	0,8	46	

Bemessungsausschaltvermögen / Rated breaking capacity **100 kA AC 240V**
30 kA DC 150V

Bemessungsstrom Rated Current	Artikel Nr. Article No.	Gewicht Weight	Schmelz- integral Pre-Arcing- I ² t-Value	Ausschalt- integral Total I ² t-Value	Leistungs- abgabe Power Loss
A		kg / 1	A ² s	A ² s	W
5	50 076 06.5	0,01	1,7	9,5	1,5
6	50 076 06.6	0,01	2,9	18	1,7
10	50 076 06.10	0,01	4,2	24	3,3
12	50 076 06.12	0,01	8,0	41	2,0
16	50 076 06.16	0,01	18	92	2,4
20	50 076 06.20	0,01	25	130	3,3

Applikationskoeffizienten / Application coefficients

(Weiterführende Informationen siehe Seite 13 / for more information see page 13)

a	A2	B1 max.	B2	Cf3
130	0,55	1,25	0,6	0,8

240 V

Ø 8,4 x 38 mm

Zeit/Strom-Kennlinien
Time-current characteristics

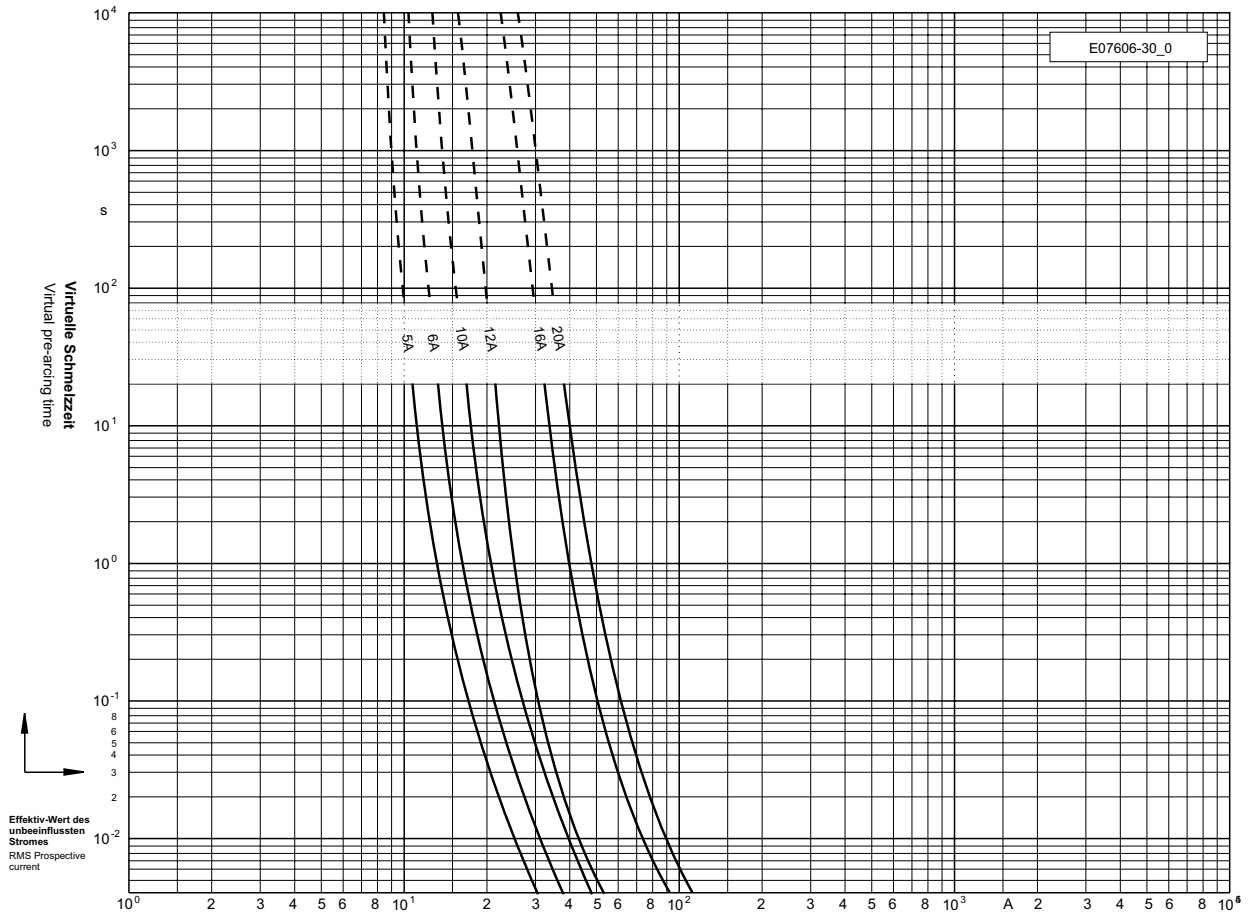

Durchlass-Strom
Cut-off current

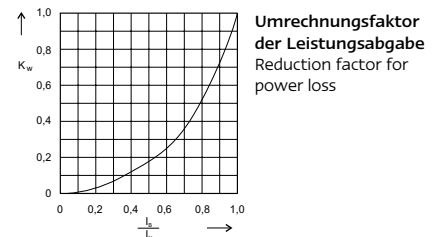
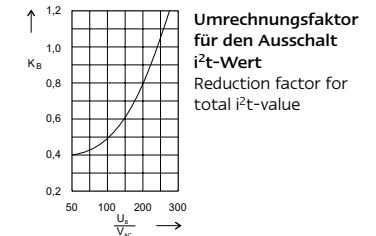
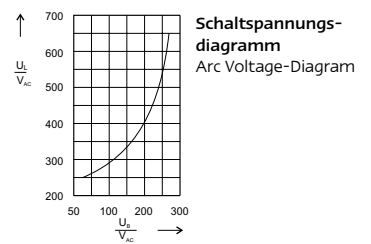
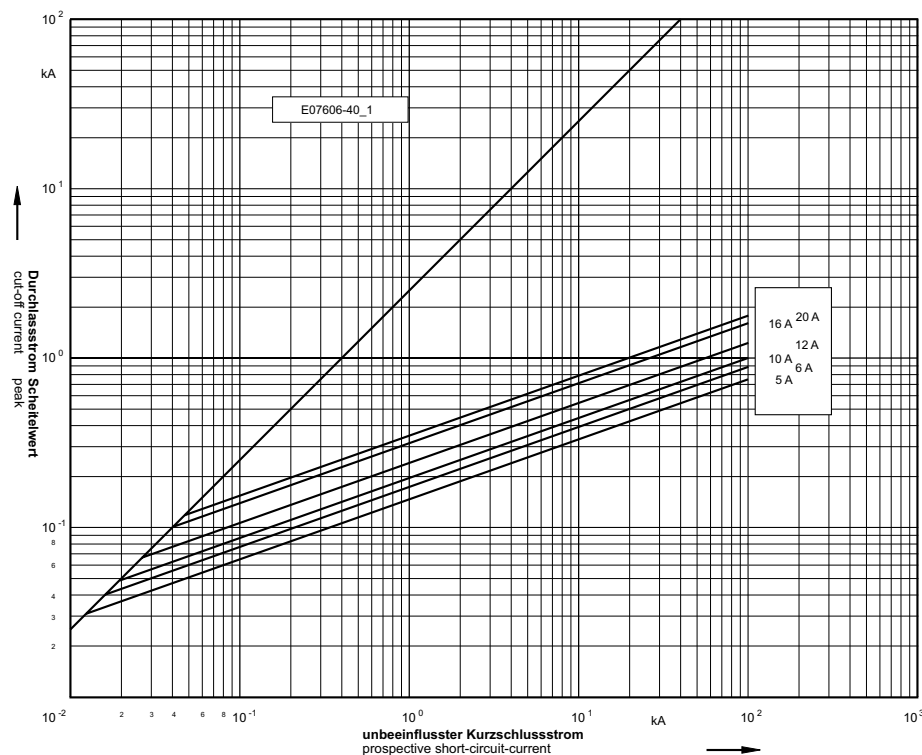

240 V

Ø 17,5 x 41,8 mm

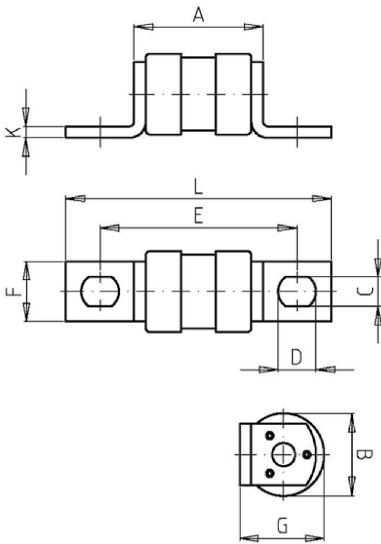

Verpackungseinheit / Packing unit: 10 Stück / 10 pieces

Betriebsklasse / Class aR	IEC 60 269-4 VDE 0636-4 BS 88-4
-------------------------------------	--

Bemessungs- spannung Rated Voltage	Artikel Nr. Article No	Größe Size	Typ Type	Bemessungsstrom Rated Current
V		mm		A
240	50 053 06	17,5 x 41,8	SLET	6-180

Artikel Nr. Article No.	Länge Length									
	A	B	C	D	E	F	G	K	L	
	mm	mm	mm	mm	mm	mm	mm	mm	mm	
50 053 06	27,5	17,6	6,35	8	41,8	13	18,5	2,5	56,5	

Bemessungsausschaltvermögen / Rated breaking capacity **100 kA AC 240V**
30 kA DC 150V

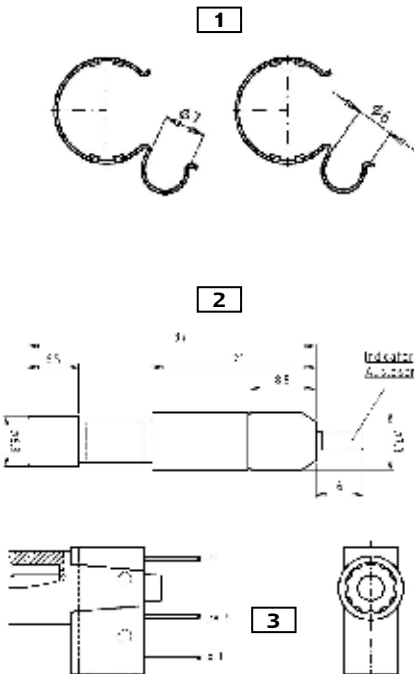

Optionales Zubehör Optional Accessories	Artikel Nr. Article No.
1 URE Set Clips Ø 17,5 mm	58 053 04
2 URE Kennmeldersicherung URE Trip Indicator fuse	58 053 07
3 URE Meldeschalter URE-Switch	58 053 05.1

Bemessungsstrom Rated Current	Artikel Nr. Article No.	Gewicht Weight	Schmelz- integral Pre-Arcing- I ² t-Value	Ausschalt- integral Total I ² t-Value	Leistungs- abgabe Power Loss
A		kg / 1	A ² s	A ² s	W
				@ AC 240 V	
6	50 053 06.6	0,03	2,9	16	1,7
7	50 053 06.7	0,03	2,9	18	1,8
10	50 053 06.10	0,03	4,2	24	3,3
12	50 053 06.12	0,03	8,0	41	2,0
16	50 053 06.16	0,03	18	92	2,4
20	50 053 06.20	0,03	25	130	3,3
25	50 053 06.25	0,03	39	260	3,6
32	50 053 06.32	0,03	40	270	4,5
35	50 053 06.35	0,03	63	430	5,0
40	50 053 06.40	0,03	100	700	5,3
50	50 053 06.50	0,03	130	900	6,7
63	50 053 06.63	0,03	250	1.700	7,7
75	50 053 06.75	0,03	330	2.300	9,4
80	50 053 06.80	0,03	420	2.900	9,7
100	50 053 06.100	0,03	620	4.300	13
125	50 053 06.125	0,03	1.000	6.800	16
160	50 053 06.160	0,03	1.500	10.200	22
180	50 053 06.180	0,03	2.300	15.700	24

Applikationskoeffizienten / Application coefficients
(Weiterführende Informationen siehe Seite 13 / for more information see page 13)

a	A2	B1 max.	B2	Cf3
130	0,6	1,25	0,6	0,8

240 V

Ø 17,5 x 41,8 mm

Zeit/Strom-
Kennlinien
Time-current
characteristics

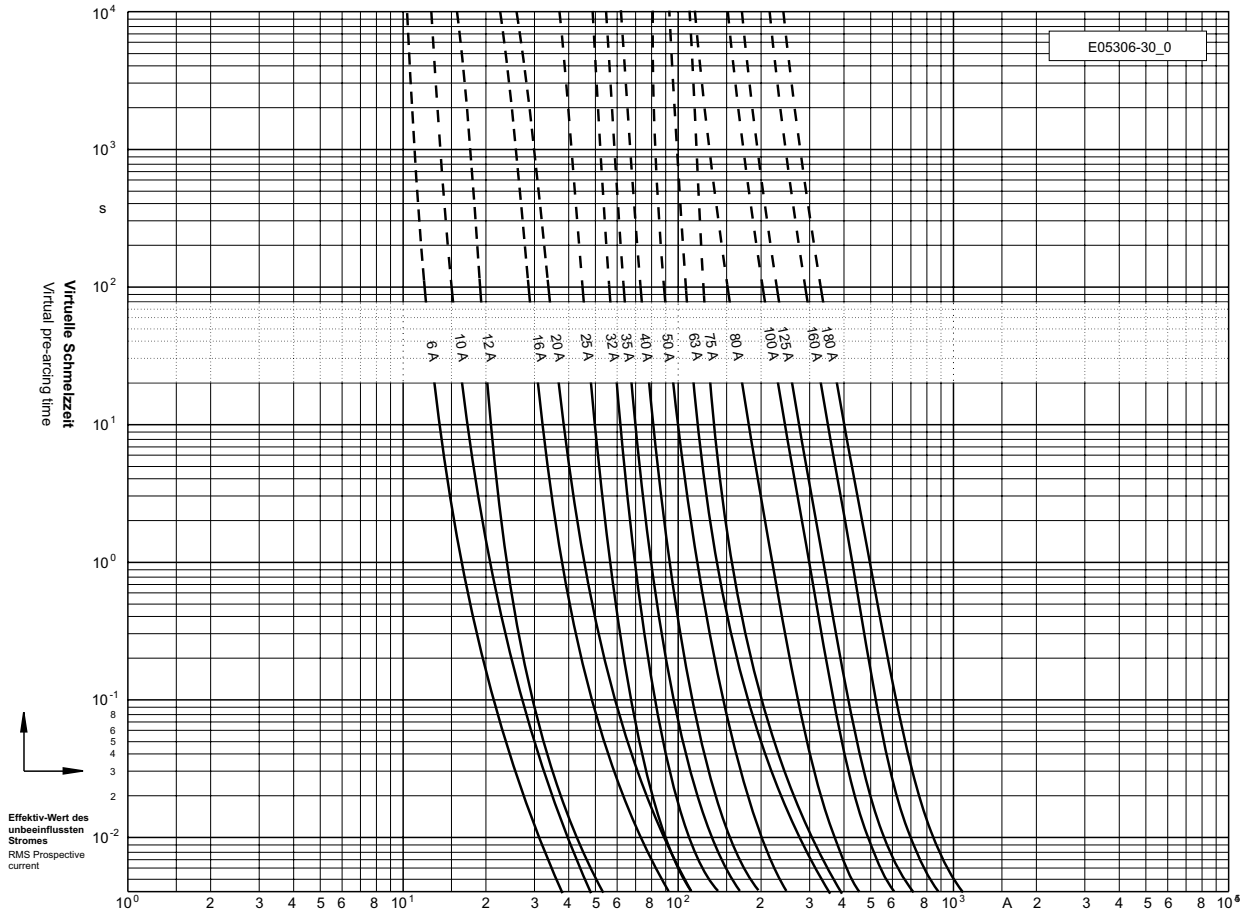

Durchlass-Strom
Cut-off current

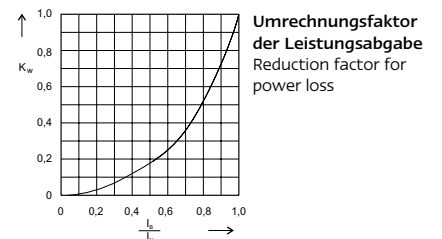
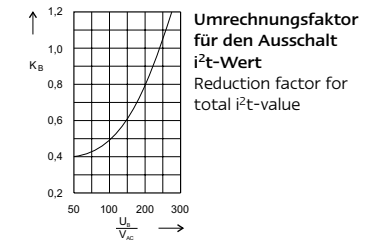
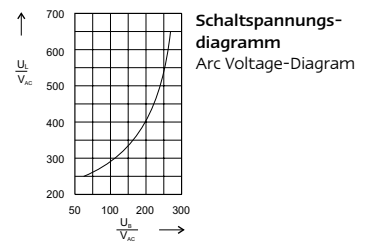
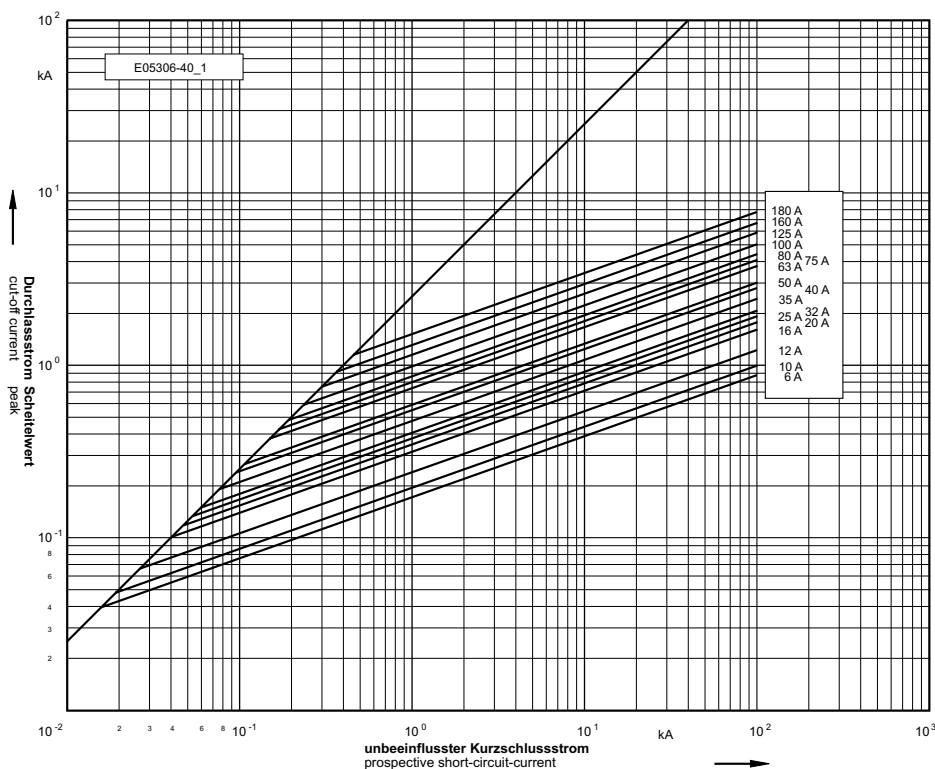

240 V

Ø 35 x 59 mm

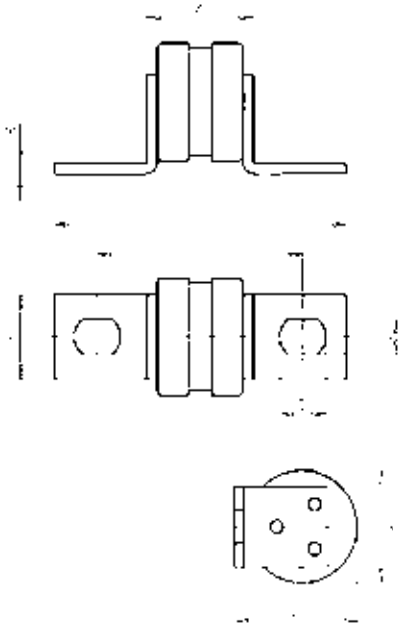

Verpackungseinheit / Packing unit: 2 Stück / 2 pieces

Betriebsklasse / Class aR	IEC 60 269-4 VDE 0636-4 BS 88-4
-------------------------------------	--

Bemessungs- spannung Rated Voltage	Artikel Nr. Article No	Größe Size	Typ Type	Bemessungsstrom Rated Current
V		mm		A
240	50 054 06	35 x 59	SLMT	100-450

Artikel Nr. Article No.	Länge Length									
	A	B	C	D	E	F	G	K	L	
	mm	mm	mm	mm	mm	mm	mm	mm	mm	
50 054 06	31	35	10,3	13,5	59	25	39	3	85	

Bemessungsausschaltvermögen / Rated breaking capacity **100 kA AC 240V**
30 kA DC 150V

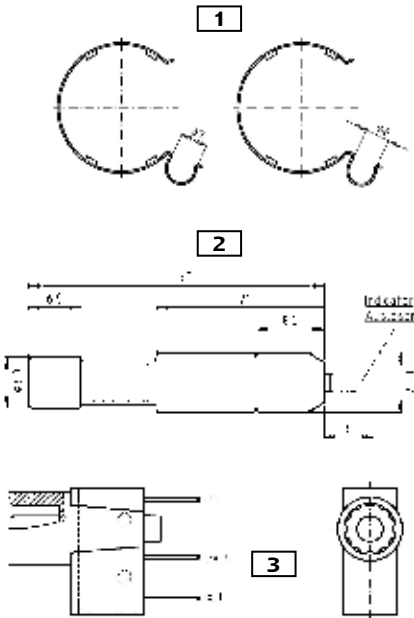

Bemessungsstrom Rated Current	Artikel Nr. Article No.	Gewicht Weight	Schmelz- integral Pre-Arcing- I ² t-Value	Ausschalt- integral Total I ² t-Value	Leistungs- abgabe Power Loss
A		kg / 1	A ² s	A ² s	W
100	50 054 06.100	0,15	620	3.700	18
125	50 054 06.125	0,15	840	5.000	20
150	50 054 06.150	0,15	1.000	6.000	22
160	50 054 06.160	0,15	1.300	8.000	23
180	50 054 06.180	0,15	2.050	12.300	26
200	50 054 06.200	0,15	2.500	15.300	27
225	50 054 06.225	0,15	3.500	20.800	29
250	50 054 06.250	0,15	4.600	28.000	34
300	50 054 06.300	0,15	7.800	47.000	36
315	50 054 06.315	0,15	7.800	48.000	36
355	50 054 06.355	0,15	13.000	76.000	38
400	50 054 06.400	0,15	18.500	113.000	40
450	50 054 06.450	0,15	27.000	163.000	46

Optionales Zubehör Optional Accessories	Artikel Nr. Article No.
1 URE Set Clips Ø 35 mm	58 054 04
2 URE Kennmeldersicherung URE Trip Indicator fuse	58 053 07
3 URE Meldeschalter URE-Switch	58 053 05.1

Applikationskoeffizienten / Application coefficients (Weiterführende Informationen siehe Seite 13 / for more information see page 13)					
a	A2	B1 max.	B2	Cf3	
130	0,55	1,25	0,6	0,8	

240 V

Ø 35 x 59 mm

Zeit/Strom-Kennlinien
Time-current characteristics

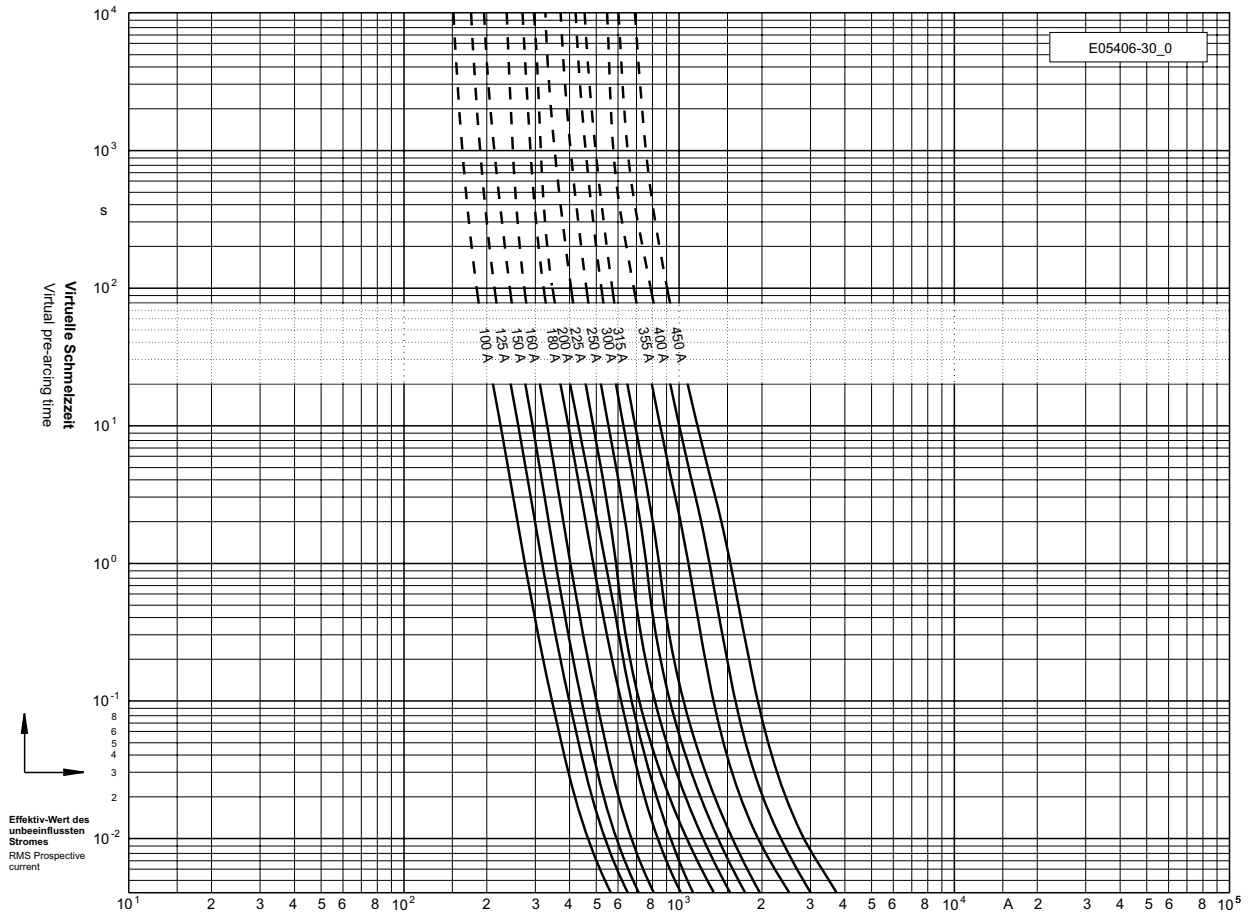

Durchlass-Strom
Cut-off current

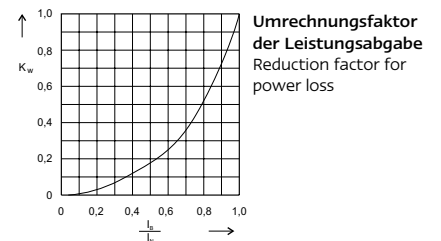
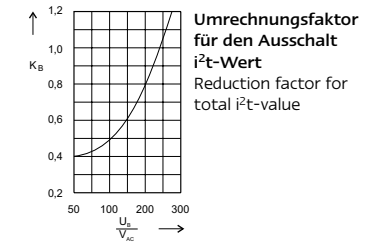
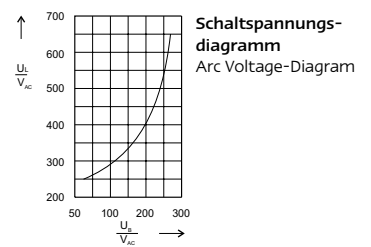
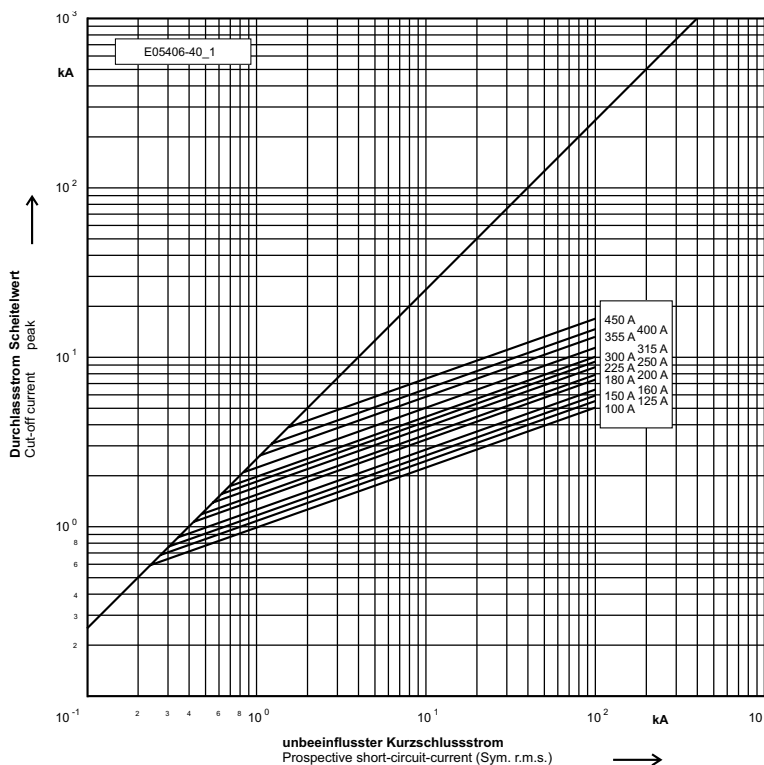

240 V

2 x 35 x 59 mm

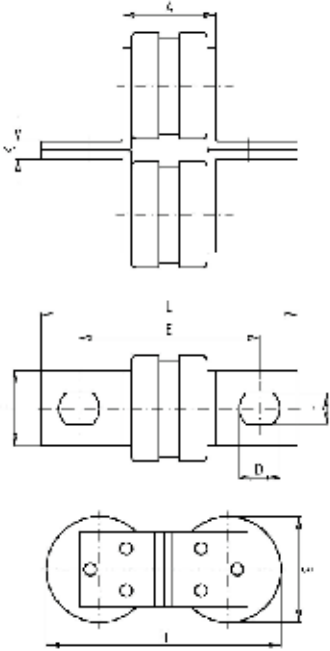

Verpackungseinheit / Packing unit: 1 Stück / 1 pieces

Betriebsklasse / Class aR	IEC 60 269-4 VDE 0636-4 BS 88 - 4
-------------------------------------	--

Bemessungs- spannung Rated Voltage	Artikel Nr. Article No	Größe Size	Typ Type	Bemessungsstrom Rated Current
V		mm		A
240	50 071 06	2 x 35 x 59	SLMMT	300-900

Artikel Nr. Article No.	Länge Lengh									
	A	B	C	D	E	F	G	H	K	L
	mm	mm	mm	mm	mm	mm	mm	mm	mm	mm
50 071 06	31	35	10,3	13,5	59	25		78	6	85

Bemessungsausschaltvermögen / Rated breaking capacity **100 kA AC 240V**
30 kA DC 150V

Bemessungsstrom Rated Current	Artikel Nr. Article No.	Gewicht Weight	Schmelz- integral Pre-Arcing- I ² t-Value	Ausschalt- integral Total I ² t-Value	Leistungs- abgabe Power Loss
A		kg / 1	A ² s	A ² s	W
300	50 071 06.300	0,29	5.300	32.000	47
350	50 071 06.350	0,29	8.200	50.000	51
400	50 071 06.400	0,29	10.000	61.000	55
450	50 071 06.450	0,29	19.000	116.000	56
500	50 071 06.500	0,29	34.000	205.000	59
630	50 071 06.630	0,29	50.000	305.000	62
710	50 071 06.710	0,29	70.000	427.000	72
800	50 071 06.800	0,29	106.000	647.000	74
900	50 071 06.900	0,29s	150.000	915.000	90

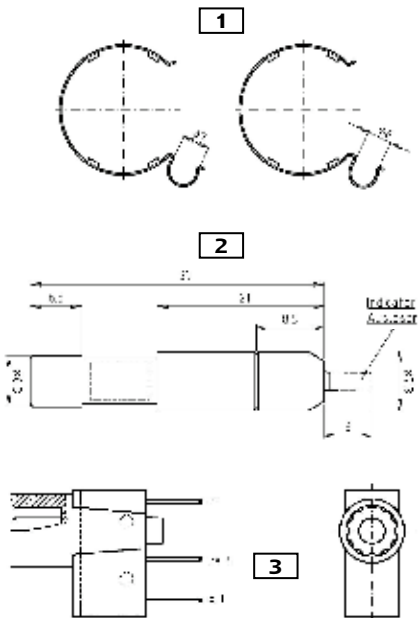

Optionales Zubehör Optional Accessories	Artikel Nr. Article No.
1 URE Set Clips Ø 35 mm	58 054 04
2 URE Kennmeldersicherung URE Trip Indicator fuse	58 053 07
3 URE Meldeschalter URE-Switch	58 053 05.1

Applikationskoeffizienten / Application coefficients (Weiterführende Informationen siehe Seite 13 / for more information see page 13)					
a	A2	B1 max.	B2	Cf3	
130	0,55	1,25	0,6	0,8	

240 V

2 x 35 x 59 mm

Zeit/Strom-Kennlinien
Time-current characteristics

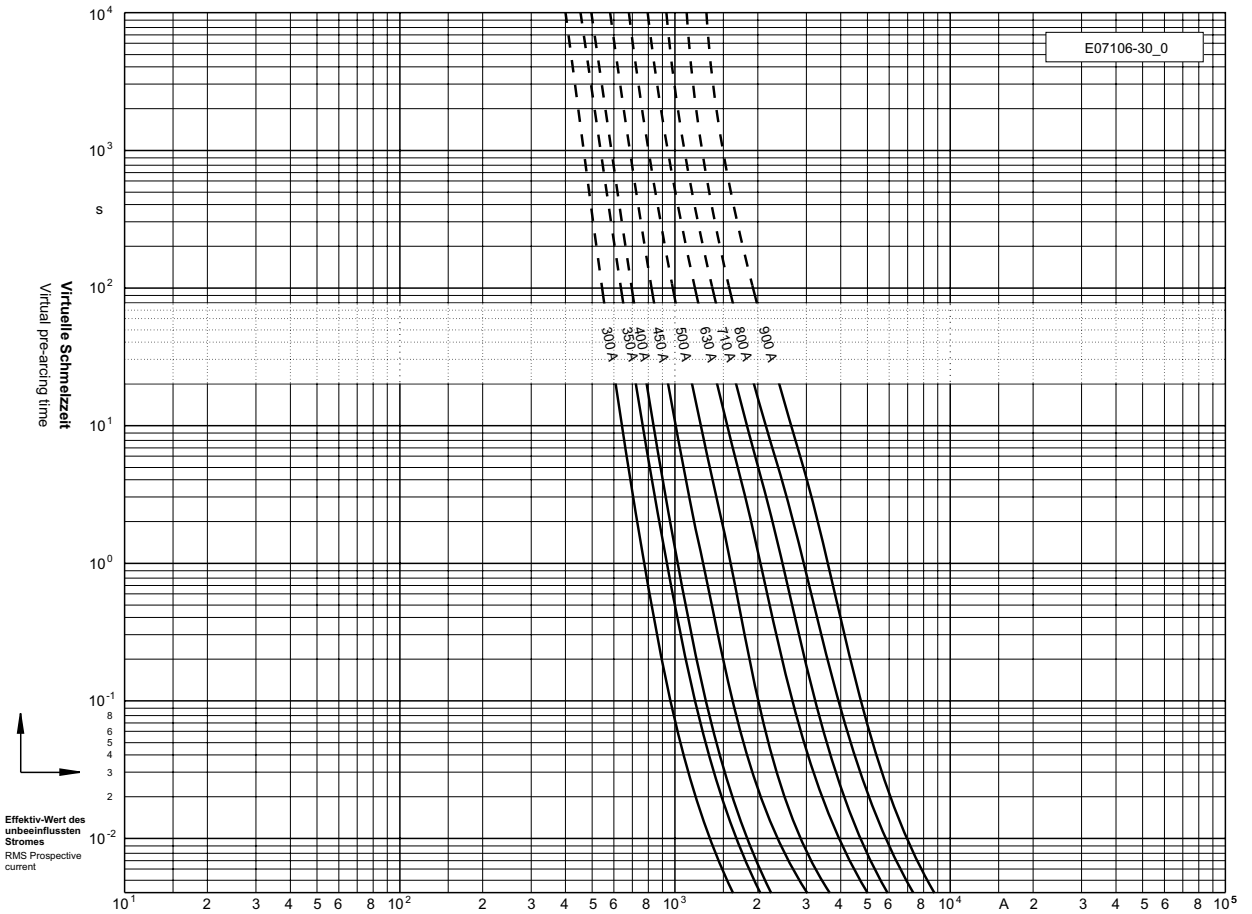

Durchlass-Strom
Cut-off current

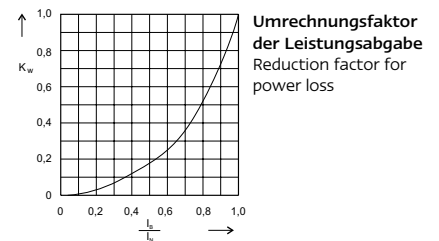
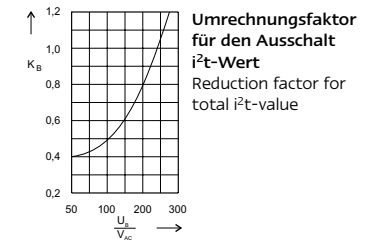
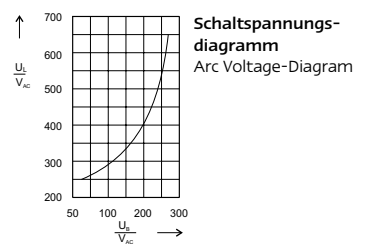
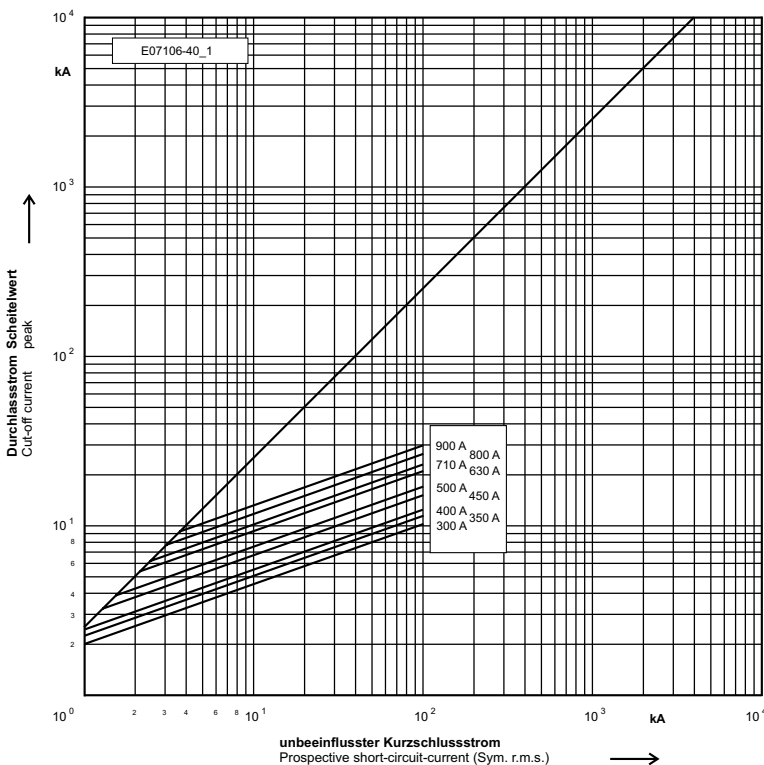

690 V

Ø 8,4 x 64,3 mm

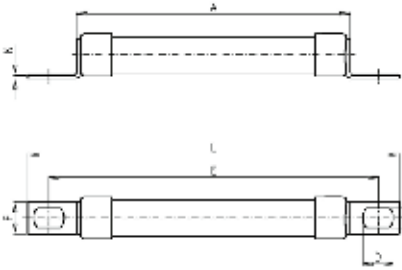

Verpackungseinheit / Packing unit: 50 Stück / 50 pieces

Betriebsklasse / Class aR	IEC 60 269-4 VDE 0636-4 BS 88-4			
-------------------------------------	---------------------------------------	--	--	--

Bemessungs- spannung Rated Voltage	Artikel Nr. Article No	Größe Size	Typ Type	Bemessungsstrom Rated Current
V		mm		A
690	50 077 06	8,4 x 64,3	SCT	6-20

Artikel Nr. Article No.	Länge Length									
	A	B	C	D	E	F	G	K	L	
	mm	mm	mm	mm	mm	mm	mm	mm	mm	
50 077 06	53,5	8,4	4	6	64,3	6,4	9	0,8	73	

Bemessungsausschaltvermögen / Rated breaking capacity **100 kA AC 690V**
30 kA DC 450V

Bemessungsstrom Rated Current	Artikel Nr. Article No.	Gewicht Weight	Schmelz- integral Pre-Arcing- I ² t-Value	Ausschalt- integral Total I ² t-Value	Leistungs- abgabe Power Loss
A		kg / 1	A ² s	A ² s	W
6	50 077 06.6	0,01	3	20	3,2
10	50 077 06.10	0,01	8	53	3,7
12	50 077 06.12	0,01	11	77	3,9
16	50 077 06.16	0,01	18	120	5,5
20	50 077 06.20	0,01	32	215	7,5

Applikationskoeffizienten / Application coefficients

(Weiterführende Informationen siehe Seite 13 / for more information see page 13)

a	A2	B1 max.	B2	Cf3
130	0,6	1,25	0,6	0,8

690 V

Ø 8,4 x 64,3 mm

Zeit/Strom-Kennlinien
Time-current characteristics

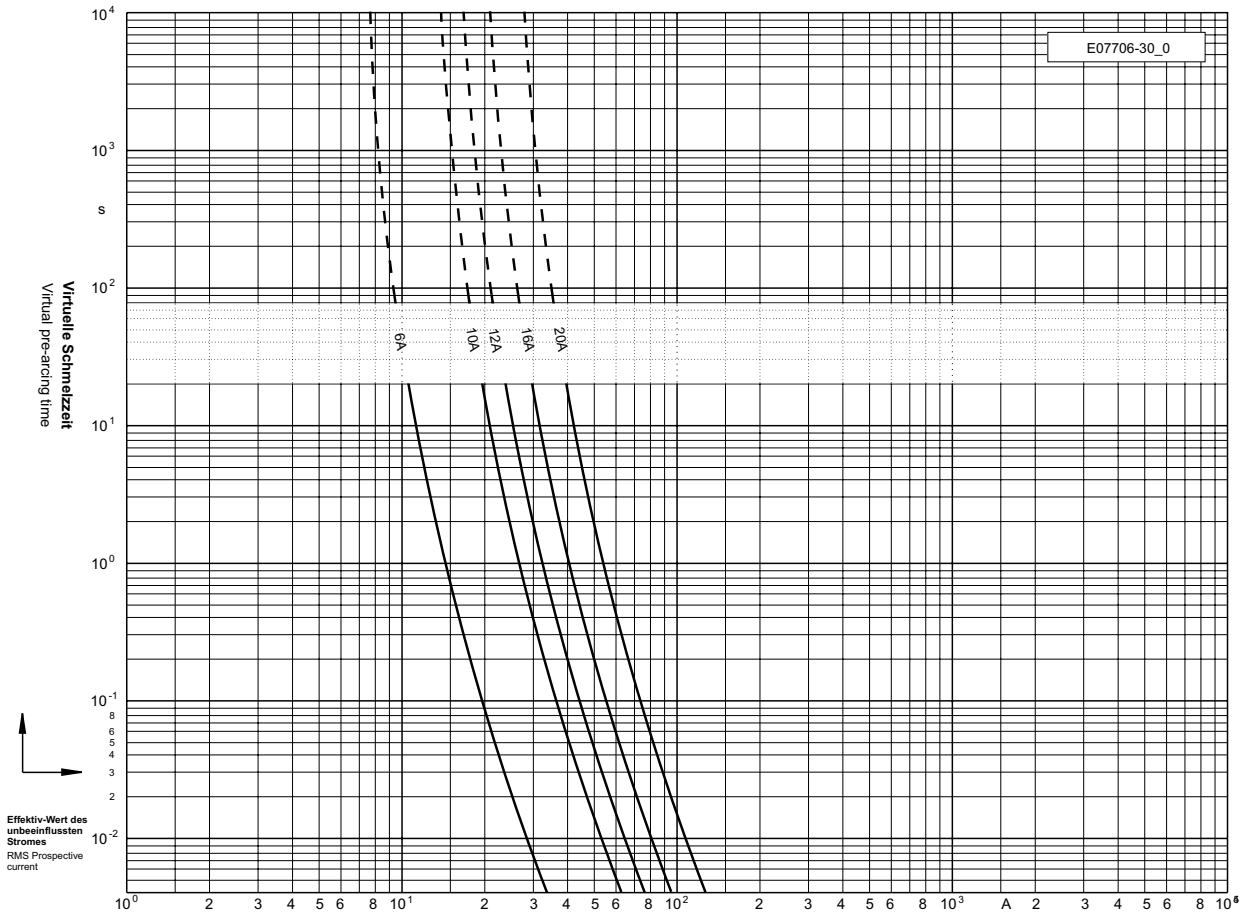

Durchlass-Strom
Cut-off current

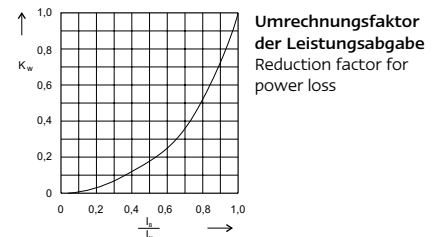
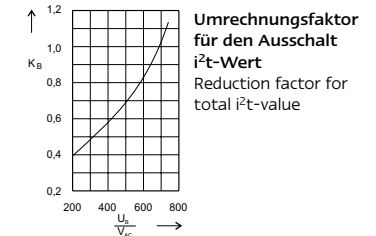
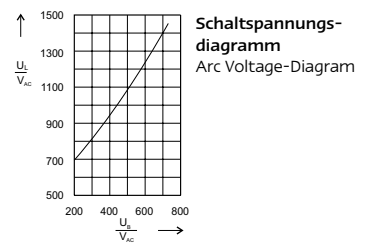
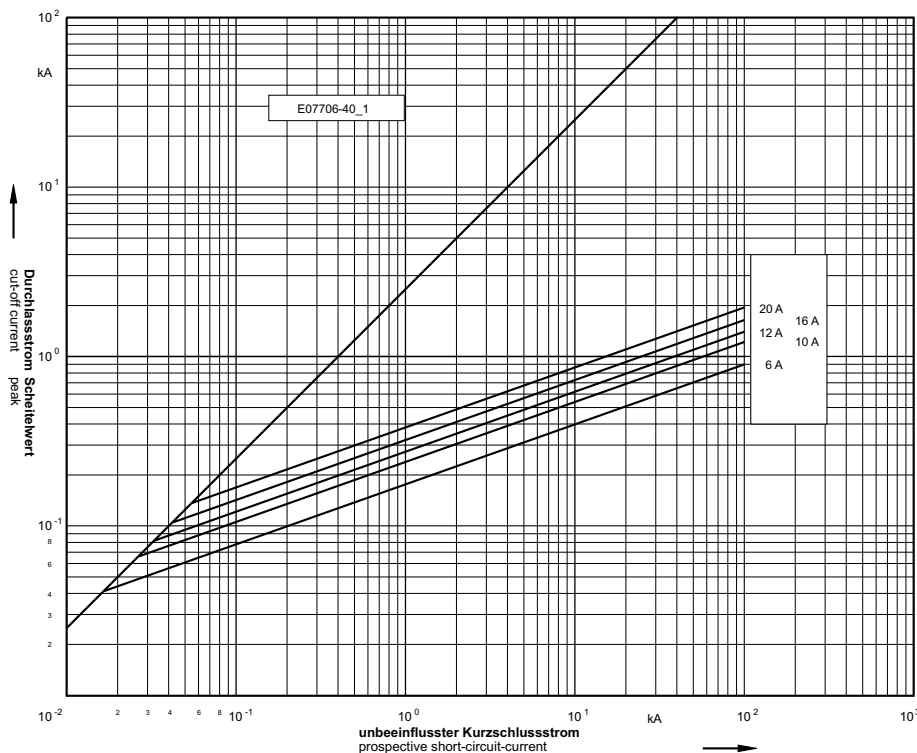

690 V

Ø 17,5 x 63,5 mm

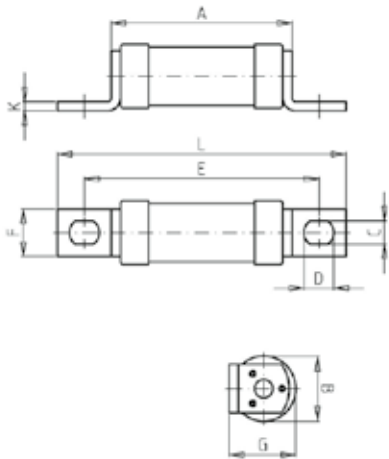

Verpackungseinheit / Packing unit: 10 Stück / 10 pieces

Betriebsklasse / Class aR	IEC 60 269-4 VDE 0636-4 BS 88-4
-------------------------------------	--

Bemessungs- spannung Rated Voltage	Artikel Nr. Article No	Größe Size	Typ Type	Bemessungsstrom Rated Current
V		mm		A
690	50 073 06	17,5 x 63,5	SET	8-32
			SFT	35-110

Artikel Nr. Article No.	Länge Length									
	A	B	C	D	E	F	G	K	L	
	mm	mm	mm	mm	mm	mm	mm	mm	mm	mm
50 073 06	48,6	17,6	6,35	8	63	13	18,5	2,5	77,6	

Bemessungsausschaltvermögen / Rated breaking capacity **100 kA AC 690V**
30 kA DC 450V

Bemessungsstrom Rated Current	Artikel Nr. Article No.	Gewicht Weight	Schmelz- integral Pre-Arcing- I ² t-Value	Ausschalt- integral Total I ² t-Value	Leistungs- abgabe Power Loss
A		kg / 1	A ² s	A ² s	W
8	50 073 06.8	0,04	5,0	30	2,8
10	50 073 06.10	0,04	8,0	45	3,4
16	50 073 06.16	0,04	18	100	5,0
20	50 073 06.20	0,04	32	140	6,0
25	50 073 06.25	0,04	25	110	7,0
32	50 073 06.32	0,04	60	260	8,0
35	50 073 06.35	0,04	63	280	9,5
40	50 073 06.40	0,04	80	330	10
50	50 073 06.50	0,04	190	780	12
63	50 073 06.63	0,04	420	1.900	15
80	50 073 06.80	0,04	520	2.500	19
90	50 073 06.90	0,04	620	2.800	21
100	50 073 06.100	0,04	740	3.100	23
110	50 073 06.110	0,04	1.000	4.400	26

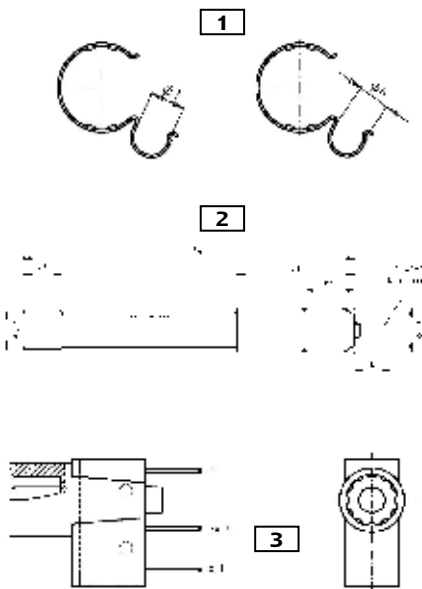

Optionales Zubehör Optional Accessories	Artikel Nr. Article No.
1 URE Set Clips Ø 17,5 mm	58 053 04
2 URE Kennmeldersicherung URE Trip Indicator fuse	58 073 07
3 URE Meldeschalter URE-Switch	58 053 05.1

Applikationskoeffizienten / Application coefficients (Weiterführende Informationen siehe Seite 13 / for more information see page 13)					
a	A2	B1 max.	B2	Cf3	
130	0,6	1,25	0,6	0,8	

690 V

Ø 17,5 x 63,5 mm

Zeit/Strom-Kennlinien
Time-current characteristics

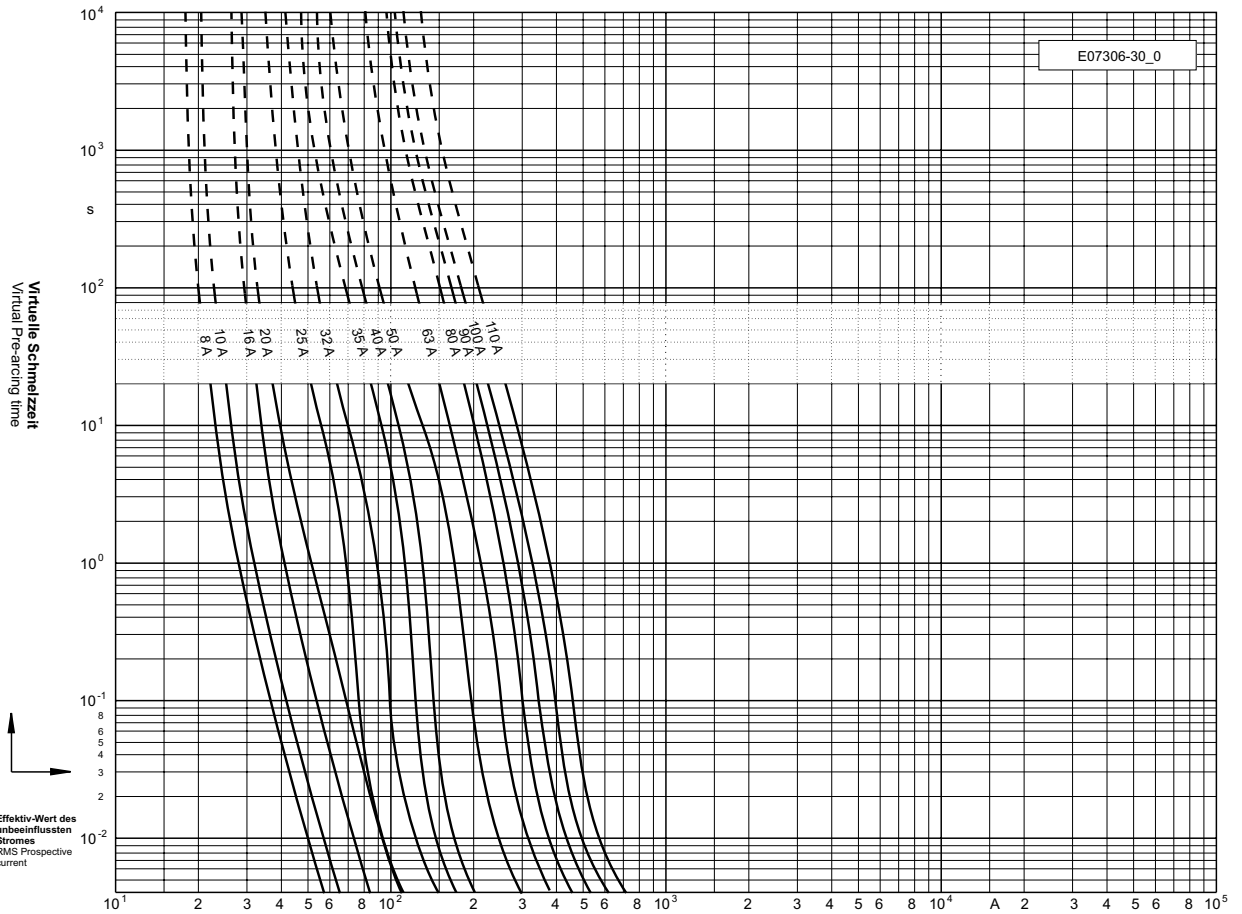

Durchlass-Strom
Cut-off current

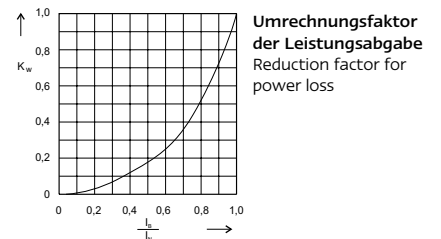
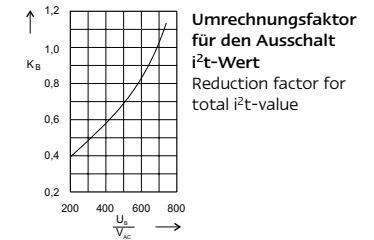
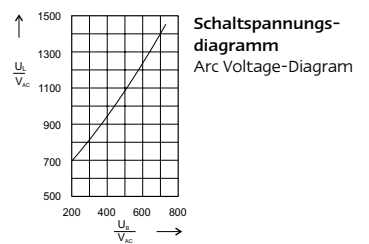
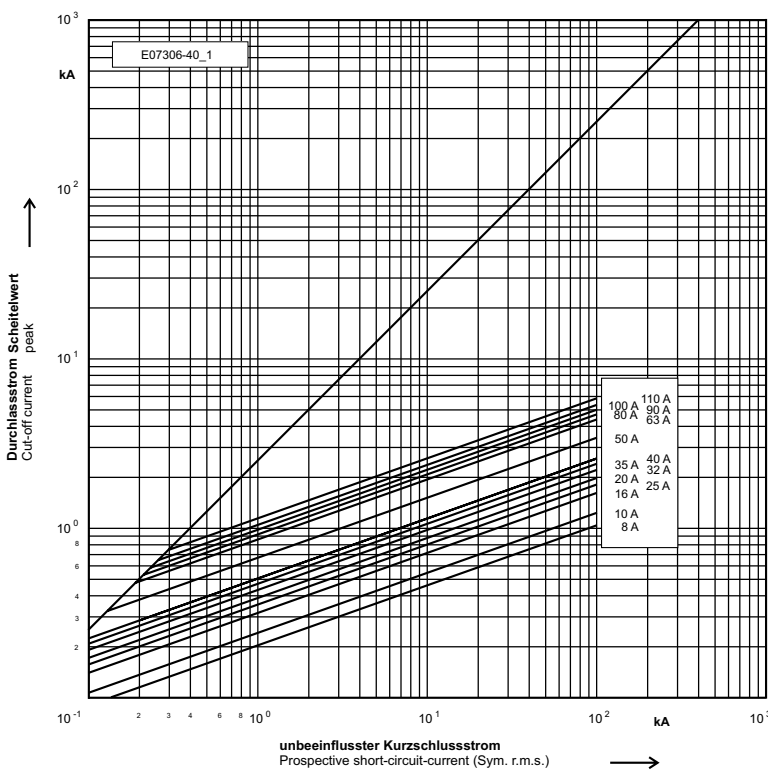

690 V

Ø 35 x 85 mm

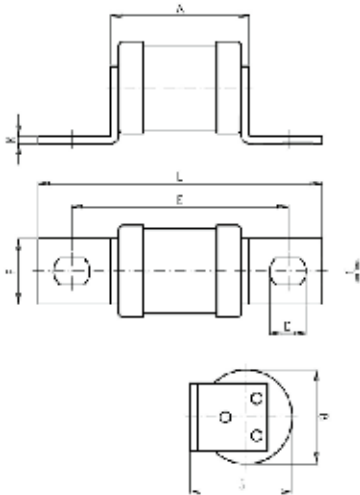

Verpackungseinheit / Packing unit: 3 Stück / 3 pieces

Betriebsklasse / Class aR	IEC 60 269-4 VDE 0636-4 BS 88-4			
-------------------------------------	---------------------------------------	--	--	--

Bemessungs- spannung Rated Voltage	Artikel Nr. Article No	Größe Size	Typ Type	Bemessungsstrom Rated Current
V		mm		A
690	50 074 06	35 x 85	SMT	100-355

Artikel Nr. Article No.	Länge Length								
	A	B	C	D	E	F	G	K	L
	mm	mm	mm	mm	mm	mm	mm	mm	mm
50 074 06	53,5	35	10,3	13,5	82,5	25	39	3	107,5

Bemessungsausschaltvermögen / Rated breaking capacity **100 kA AC 690V**
30 kA DC 450V

Bemessungsstrom Rated Current	Artikel Nr. Article No.	Gewicht Weight	Schmelz- integral Pre-Arcing- I ² t-Value	Ausschalt- integral Total I ² t-Value	Leistungs- abgabe Power Loss
A		kg / 1	A ² s	A ² s	W
100	50 074 06.100	0,2	1.000	6.500	22
125	50 074 06.125	0,2	1.700	11.000	26
150	50 074 06.150	0,2	3.800	25.000	29
160	50 074 06.160	0,2	4.600	30.000	30
180	50 074 06.180	0,2	5.600	36.000	32
200	50 074 06.200	0,2	9.000	58.000	35
250	50 074 06.250	0,2	18.000	116.000	40
315	50 074 06.315	0,2	27.000	173.000	46
355	50 074 06.355	0,2	41.000	262.000	56

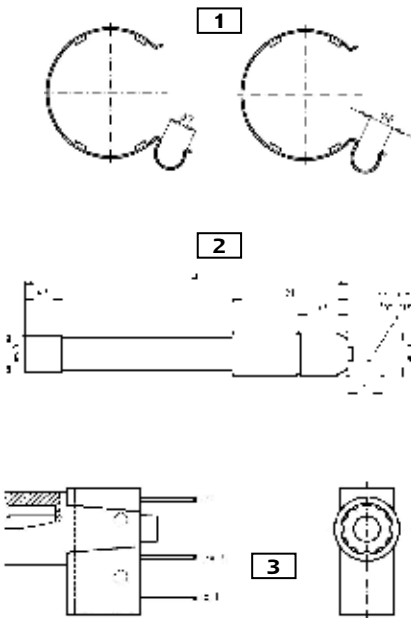

Optionales Zubehör Optional Accessories	Artikel Nr. Article No.
1 URE Set Clips Ø 35 mm	58 054 04
2 URE Kennmeldersicherung URE Trip Indicator fuse	58 073 07
3 URE Meldeschalter URE-Switch	58 053 05.1

Applikationskoeffizienten / Application coefficients (Weiterführende Informationen siehe Seite 13 / for more information see page 13)					
a	A2	B1 max.	B2	Cf3	
130	0,55	1,25	0,6	0,8	

690 V

Ø 35 x 85 mm

Zeit/Strom-
Kennlinien
Time-current
characteristics

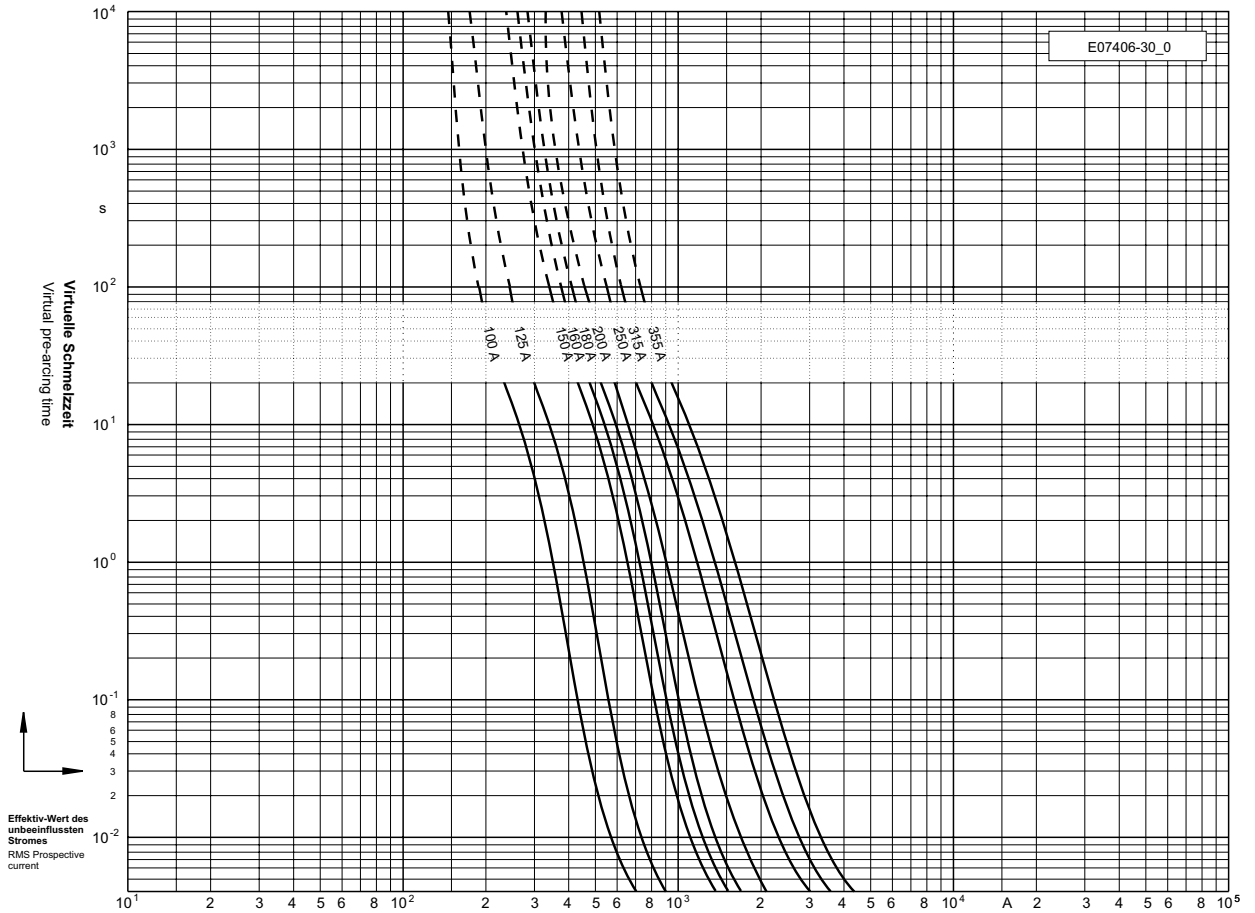

Durchlass-Strom
Cut-off current

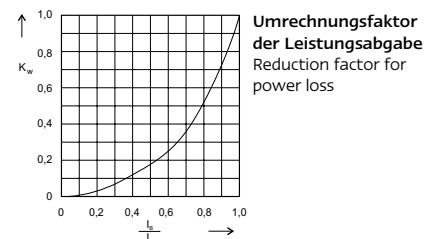
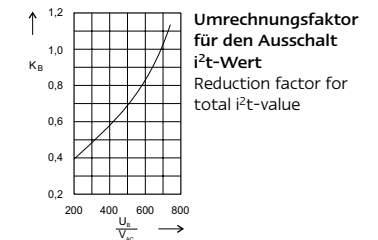
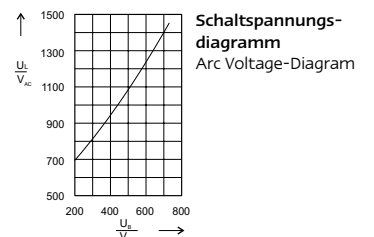
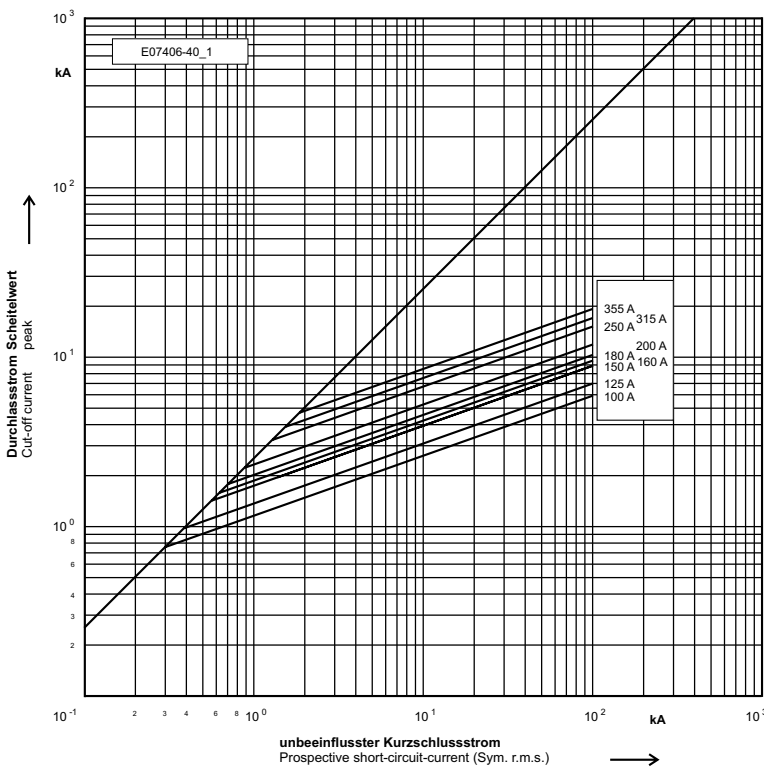

690 V

2 x 35 x 85 mm

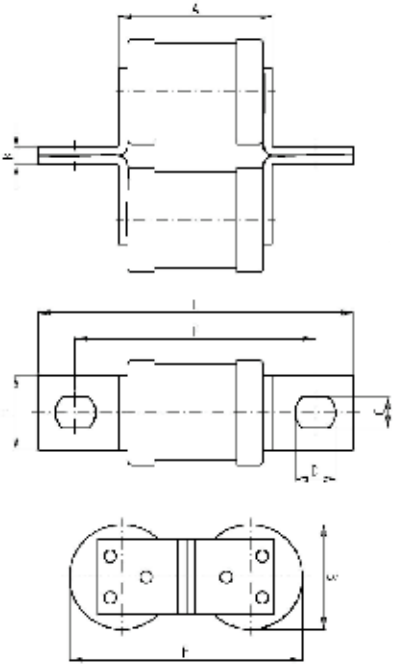

Verpackungseinheit / Packing unit: 1 Stück / 1 pieces

Betriebsklasse / Class aR	IEC 60 269-4 VDE 0636-4 BS 88-4
-------------------------------------	--

Bemessungs- spannung Rated Voltage	Artikel Nr. Article No	Größe Size	Typ Type	Bemessungsstrom Rated Current
V		mm		A
690	50 075 06	2 x 35 x 85	SMMT	180-710

Artikel Nr. Article No.	Länge Lengh									
	A	B	C	D	E	F	G	H	K	L
	mm	mm	mm	mm	mm	mm	mm	mm	mm	mm
50 075 06	53,5	35	10,3	13,5	82,5	25		78	6	107,5

Bemessungsausschaltvermögen / Rated breaking capacity **100 kA AC 690V**
30 kA DC 450V

Bemessungsstrom Rated Current	Artikel Nr. Article No.	Gewicht Weight	Schmelz- integral Pre-Arcing- I ² t-Value	Ausschalt- integral Total I ² t-Value	Leistungs- abgabe Power Loss
A		kg / 1	A ² s	A ² s	W
180	50 075 06.180	0,37	2.500	16.000	29
200	50 075 06.200	0,37	4.100	26.300	31
225	50 075 06.225	0,37	5.300	34.000	35
250	50 075 06.250	0,37	6.700	43.000	38
280	50 075 06.280	0,37	10.000	64.700	43
300	50 075 06.300	0,37	15.000	96.000	45
315	50 075 06.315	0,37	18.500	119.000	48
355	50 075 06.355	0,37	22.300	143.000	55
400	50 075 06.400	0,37	36.100	231.000	58
450	50 075 06.450	0,37	52.300	335.000	63
500	50 075 06.500	0,37	70.100	449.000	68
550	50 075 06.550	0,37	93.400	598.000	78
630	50 075 06.630	0,37	106.000	679.000	87
710	50 075 06.710	0,37	163.000	1.044.000	104

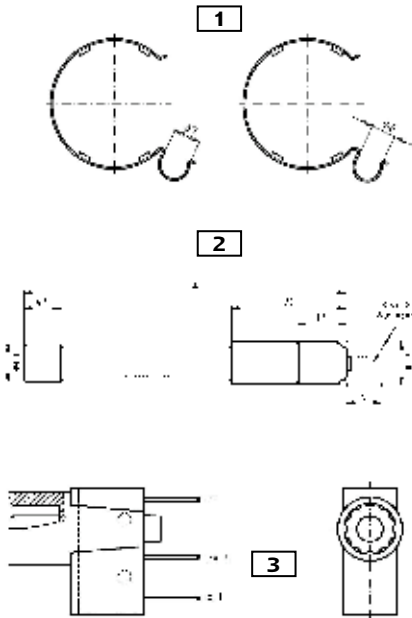

Optionales Zubehör Optional Accessories	Artikel Nr. Article No.
1 URE Set Clips Ø 35 mm	58 054 04
2 URE Kennmeldersicherung URE Trip Indicator fuse	58 073 07
3 URE Meldeschalter URE-Switch	58 053 05.1

Applikationskoeffizienten / Application coefficients
(Weiterführende Informationen siehe Seite 13 / for more information see page 13)

a	A2	B1 max.	B2	Cf3
130	0,6	1,25	0,6	0,8

690 V

2 x 35 x 85 mm

Zeit/Strom-Kennlinien
Time-current characteristics

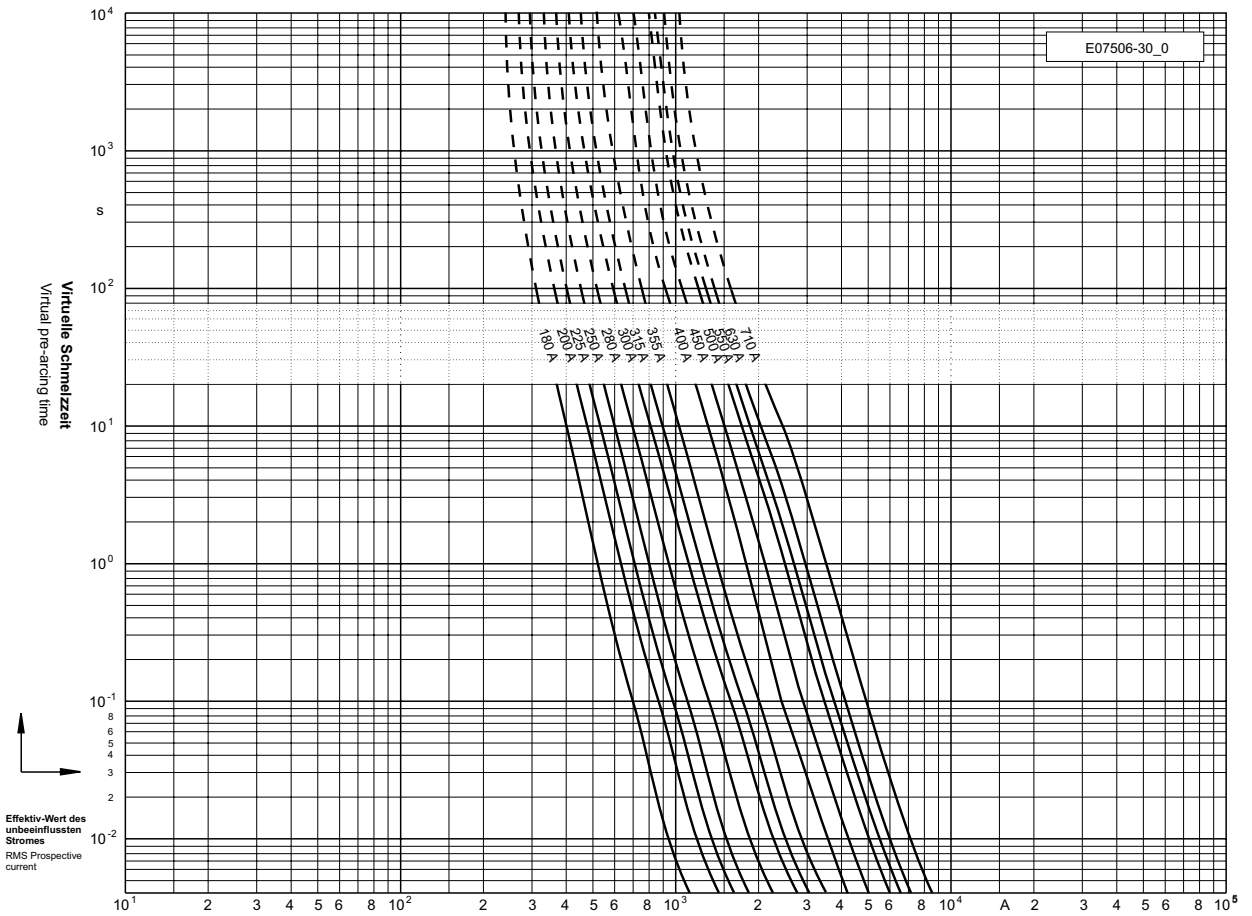

Durchlass-Strom
Cut-off current

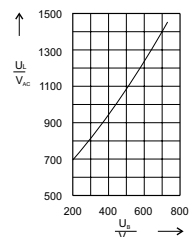
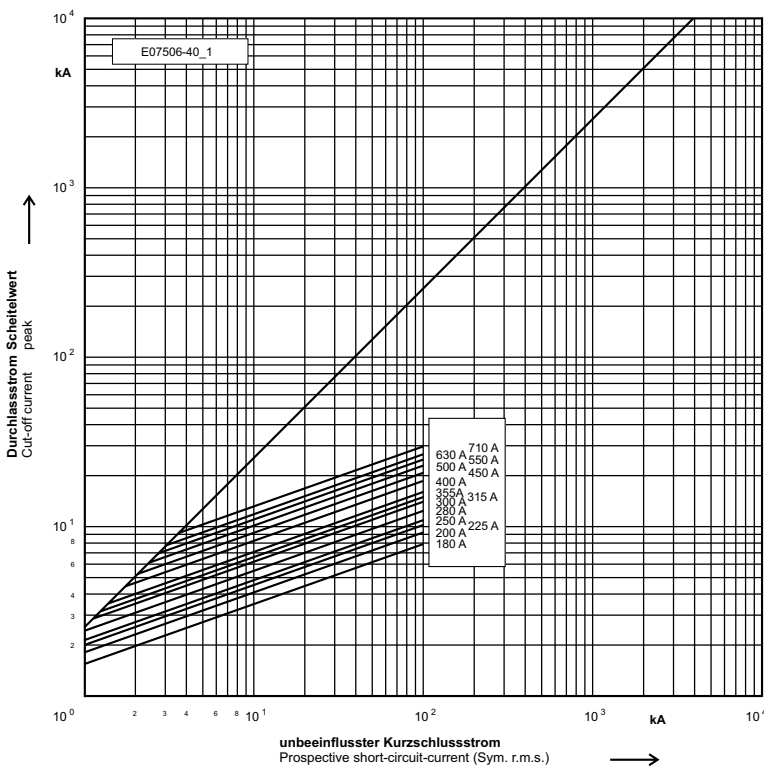

Schaltspannungsdiagramm
Arc Voltage-Diagram

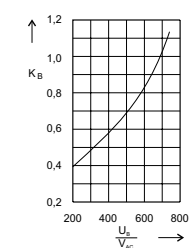

Umrechnungsfaktor für den Ausschalt i^2t -Wert
Reduction factor for total i^2t -value

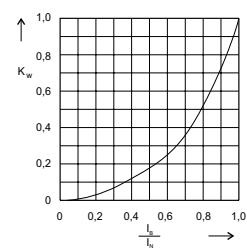

Umrechnungsfaktor der Leistungsabgabe
Reduction factor for power loss

